

CHIUSURE INOX A LEVA (cod. IM)

Attenzione! Le dimensioni riportate possono subire variazioni minime a seconda del lotto di produzione.
Si consiglia di non praticare i fori di fissaggio prima di ricevere il prodotto.

CHIUSURA A LEVA TIPO A - A.304
art. 8053A

CARICO MASSIMO DI LAVORO (kg)	CARICO MASSIMO DI TENSIONE (kg)
40	101

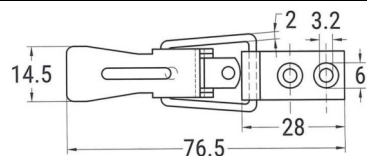
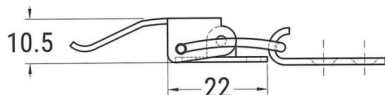

CHIUSURA A LEVA TIPO B - A.304
art. 8053B

CARICO MASSIMO DI LAVORO (kg)	CARICO MASSIMO DI TENSIONE (kg)
56	101

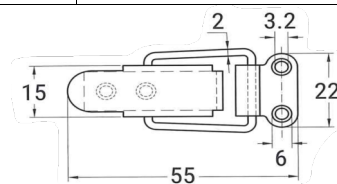
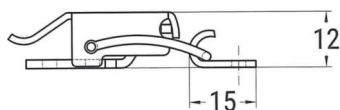

CHIUSURA A LEVA TIPO C - A.304
art. 8053C

CARICO MASSIMO DI LAVORO (kg)	CARICO MASSIMO DI TENSIONE (kg)
50	91

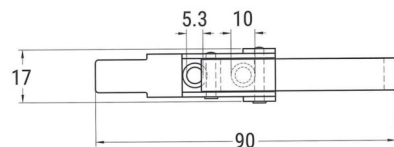
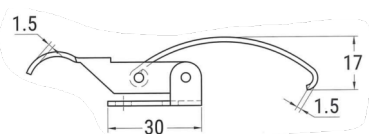

CHIUSURA A LEVA TIPO D - A.304
art. 8053D

CARICO MASSIMO DI LAVORO (kg)	CARICO MASSIMO DI TENSIONE (kg)
56	152

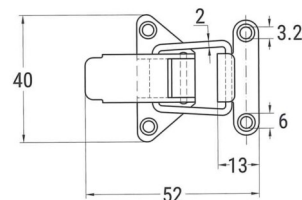
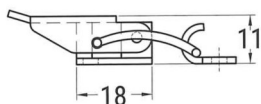

CHIUSURA A LEVA TIPO F - A.304
art. 8053F

CARICO MASSIMO DI LAVORO (kg)	CARICO MASSIMO DI TENSIONE (kg)
56	132

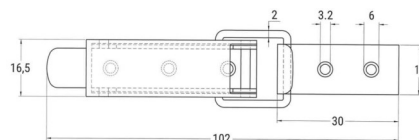
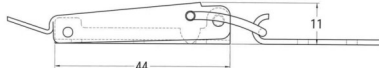

CHIUSURA A LEVA TIPO G - A.304
art. 8053G

CARICO MASSIMO DI LAVORO (kg)	CARICO MASSIMO DI TENSIONE (kg)
101	254

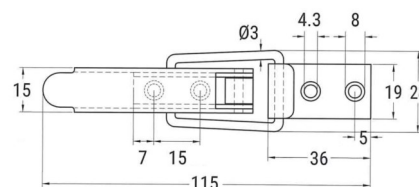
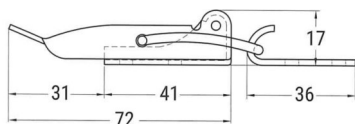

CHIUSURE INOX A LEVA (cod. IM)

Attenzione! Le dimensioni riportate possono subire variazioni minime a seconda del lotto di produzione.
Si consiglia di non praticare i fori di fissaggio prima di ricevere il prodotto.

CHIUSURA A LEVA TIPO H - A.304
art. 8053H

CARICO MASSIMO DI LAVORO (kg)	CARICO MASSIMO DI TENSIONE (kg)
203	407

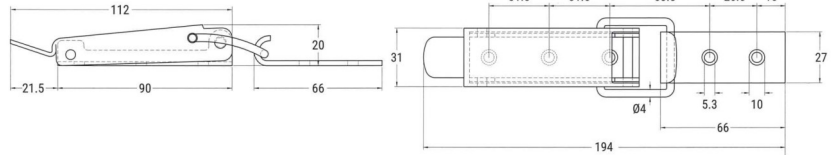

CHIUSURA A LEVA REGOLABILE TIPO I - A.304
art. 8053I

CARICO MASSIMO DI LAVORO (kg)	CARICO MASSIMO DI TENSIONE (kg)
101	142

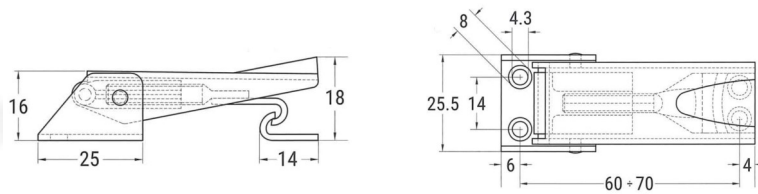

CHIUSURA A LEVA REGOLABILE TIPO L - A.304
art. 8053L

CARICO MASSIMO DI LAVORO (kg)	CARICO MASSIMO DI TENSIONE (kg)
152	305

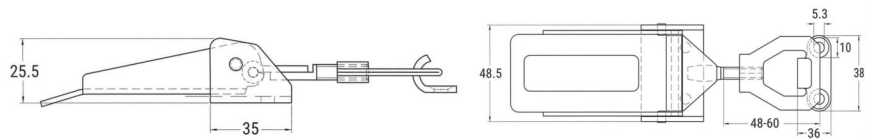

CHIUSURA A LEVA REGOLABILE TIPO M - A.304
art. 8053M

CARICO MASSIMO DI LAVORO (kg)	CARICO MASSIMO DI TENSIONE (kg)
112	254

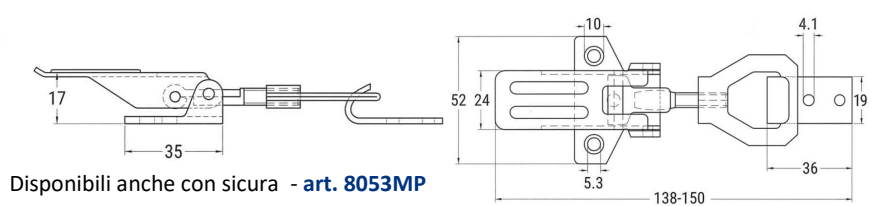
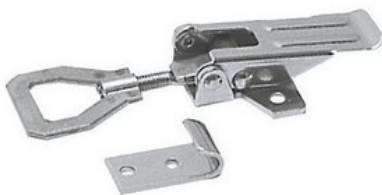

CHIUSURA A LEVA CON TRAZIONE COMPENSATA, TIPO N - A.304
art. 8053N

CARICO MASSIMO DI LAVORO (kg)	CARICO MASSIMO DI TENSIONE (kg)
50	152

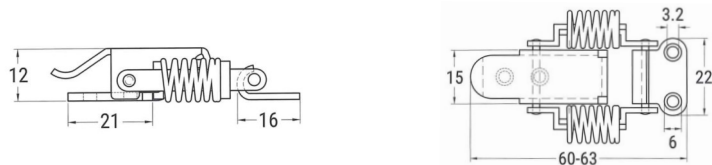

CHIUSURA A LEVA PER LUCCHETTO TIPO O - A.304
art. 8053O

CARICO MASSIMO DI LAVORO (kg)	CARICO MASSIMO DI TENSIONE (kg)
56	132

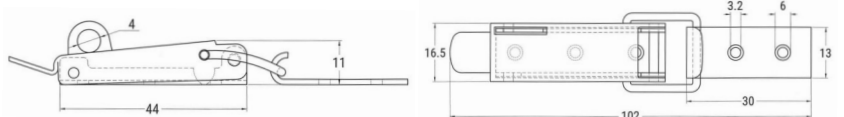

CHIUSURE INOX A LEVA (cod. IM)

Attenzione! Le dimensioni riportate possono subire variazioni minime a seconda del lotto di produzione. Si consiglia di non praticare i fori di fissaggio prima di ricevere il prodotto.

CHIUSURA A LEVA PER LUCCHETTO TIPO P - A.304
art. 8053P

CARICO MASSIMO DI LAVORO (kg)	CARICO MASSIMO DI TENSIONE (kg)
101	254

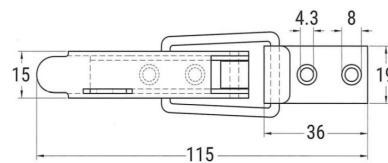
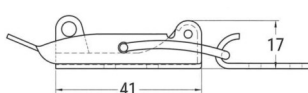

CHIUSURA A LEVA PER LUCCHETTO TIPO Q - A.304
art. 8053Q

CARICO MASSIMO DI LAVORO (kg)	CARICO MASSIMO DI TENSIONE (kg)
203	407

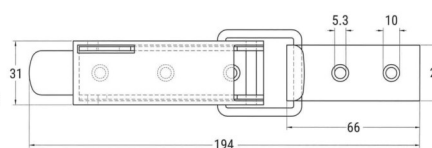
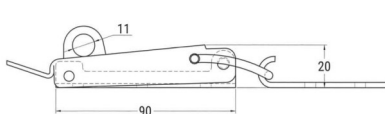

CHIUSURA PER CASSE PORTALUCCHETTO
A.304
art. 1140A109



GANCI PER CHIUSURE
(PER art. 1140A109)
A.304
art. 1142



CHIUSURA PORTALUCCHETTO
A.304
art. 8053S

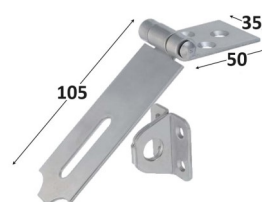

LUCCHETTI INOX (cod. IBF)

LUCCHETTO AD ARCO
art. 8051

Completo di nr. 2 chiavi

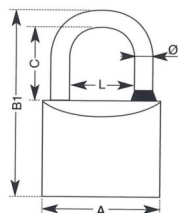

ARTICOLO		A	B1	C	L	Ø
8051C	mm	30	50	16	15	5
8051E	mm	40	61	22	22	6
8051H	mm	50	77	28	27	8

POSSIBILITÀ DEL SISTEMA KEY ALIKE
(più lucchetti con chiave unica)

LUCCHETTO AD ARCO LUNGO
art. 8051

Completo di nr. 2 chiavi

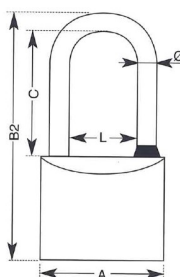

ARTICOLO		A	B2	C	L	Ø
8051CL	mm	30	66	32	15	5
8051EL	mm	40	80	41	22	6
8051HL	mm	50	98	50	27	8

CHIUSURE E MANIGLIE INOX (cod. IM - IBF - MAR)

Attenzione! Le dimensioni riportate possono subire variazioni minime a seconda del lotto di produzione. Si consiglia di non praticare i fori di fissaggio prima di ricevere il prodotto.

SERRATURA A COMPRESSIONE CON MANIGLIA A "T"

Cod. IM art. **CH220104**

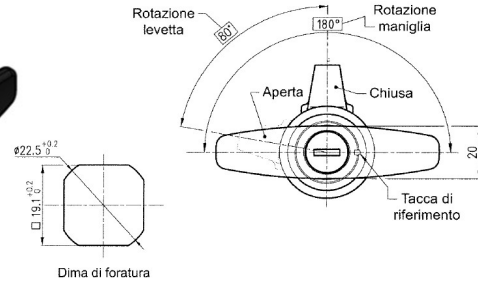
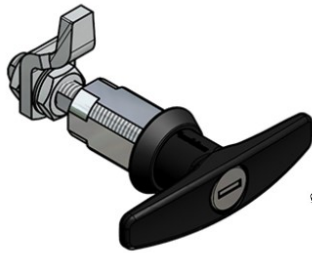

S ± 0,5	S ± 0,5 Levetta invertita	Tipo cilindro serratura
26,5 ÷ 36	52,5 ÷ 62	C31 STD CH751 2 chiavi incluse

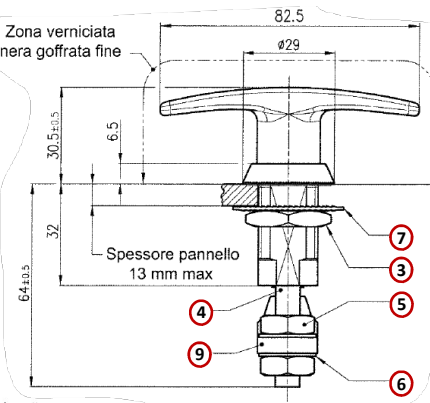
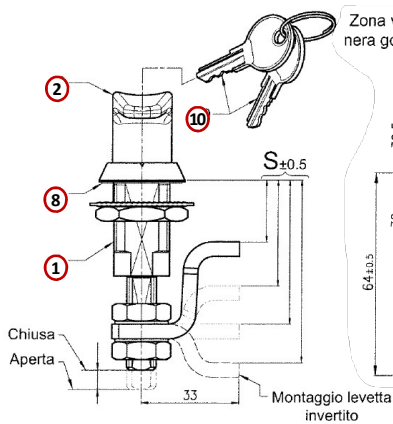

COMPONENTI	ZAMA VERNICIATA (BK) Materiale - finitura
1 Boccola	Zama - Verniciata nera
2 Maniglia a T	Zama - Verniciata nera
3 Dado M22 x 1,5 Ch. 27	Acciaio - Zinc. irid.
4 Perno di rotazione	9SMnPb36 - Zinc. irid.
5 Dado M10 (2)	Acciaio - Zinc. irid.
6 Rondella dentellata (2)	Acciaio - Zinc. irid.
7 Rondella dentellata	Acciaio - Zinc. irid.
8 Guarnizione sottotesta	NBR
9 Levetta	Acciaio - Zinc. irid.
10 Chiavi CH751 Cifratura unica (2)	Nichelate

CHIUSURA INOX 1/4 DI GIRO
Cod. MAR art. **70172HYG/A/3A**

- Corpo A.304
- Perno centrale A.304
- Vite A.304
- Dado A.304
- Aletta A.304
- O-Ring a tenuta in silicone blu

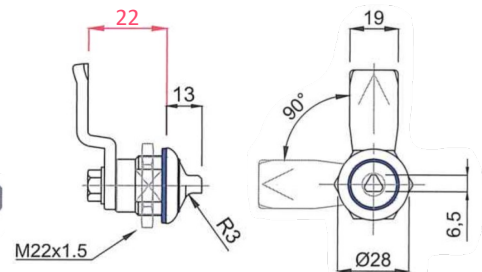

CHIAVE IN PLASTICA x 70172HYG
Cod. MAR art. **70090/CH-A**

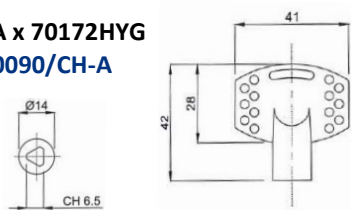

CHIUSURA A TAVELLINO INOX
Cod. IBF art. **0921**

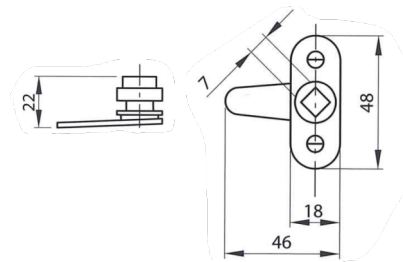

CHIUSURA A CRICCHETTO INOX
Cod. IBF art. **0912**

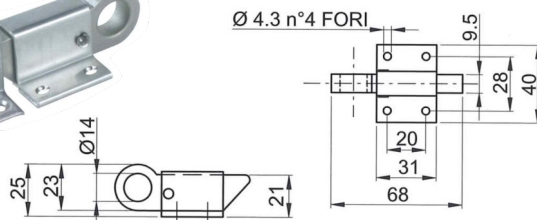

CHIAVE IN ZAMA PER TAVELLINO
Cod. IBF art. **0921AM**



CHIUSURE E MANIGLIE INOX (cod. IM)

Attenzione! Le dimensioni riportate possono subire variazioni minime a seconda del lotto di produzione. Si consiglia di non praticare i fori di fissaggio prima di ricevere il prodotto.

MANIGLIA PESANTE DA INCASSO
art. FE790A

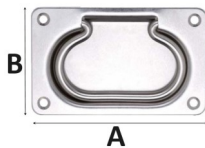

A	B	Spessore	N. fori	Ø fori	Peso
mm	mm	mm		mm	gr
170	105	2	4	5	500

MANIGLIA PER CASSE
art. FE720A

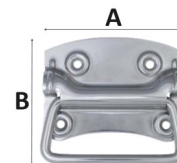

A	B	Spessore	N. fori	Ø fori	Peso
mm	mm	mm		mm	gr
100	80	1,5	4	4,5	180

MANIGLIA PER CASSE CON MOLLA - A.304
art. FE770A

Impugnatura in gomma

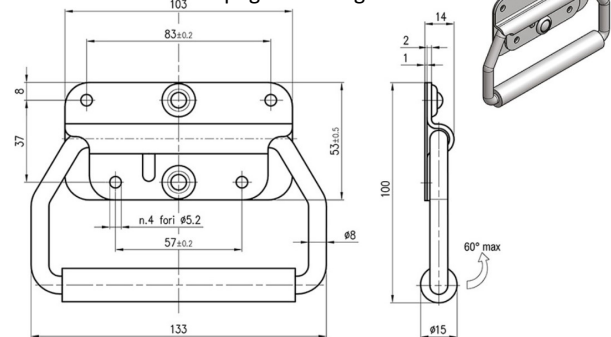

ALZAPAILO CON ANELLO MICROFUSO - A.316
art. 8241

Esecuzione lucida

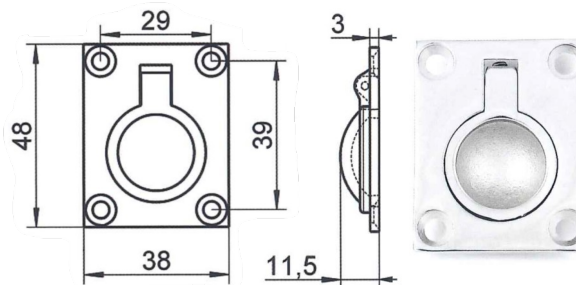

ALZAPAILO CON ANELLO ROBUSTO MICROFUSO - A.316
art. 8242

Esecuzione lucida

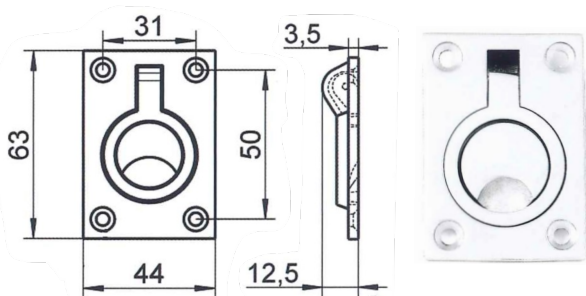

ALZAPAILO CON ANELLO MICROFUSO - A.316
art. 8243

Esecuzione lucida

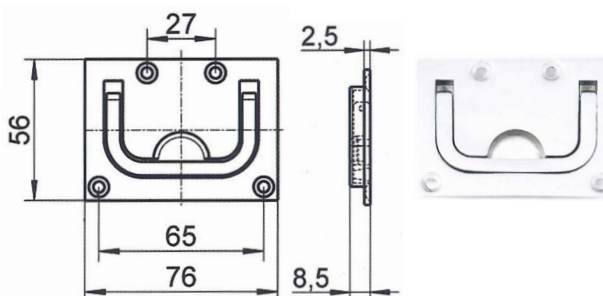

CHIUSURA A INCASSO CON SERRATURA - A.304
art. CH5S

Esecuzione lucidata

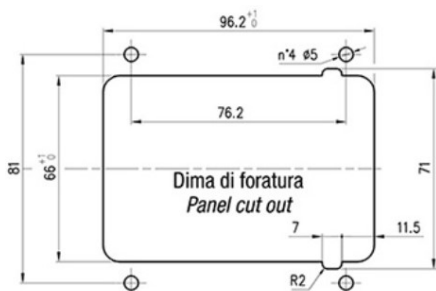

Dima di foratura
Panel cut out

